

# MADE<sup>+</sup>

## CAMPTON

Campton Corner Media Unit

Campton, meuble d'angle

Campton mediameubel

Campton Lowboard



**GB** Recommendations for the continual safe use of this product are stated on the final page of these instructions. Please retain for future reference.

**FR** Les conseils d'utilisation de ce produit sont indiqués sur la dernière page de ces instructions. Veuillez les conserver pour vous y référer si besoin.



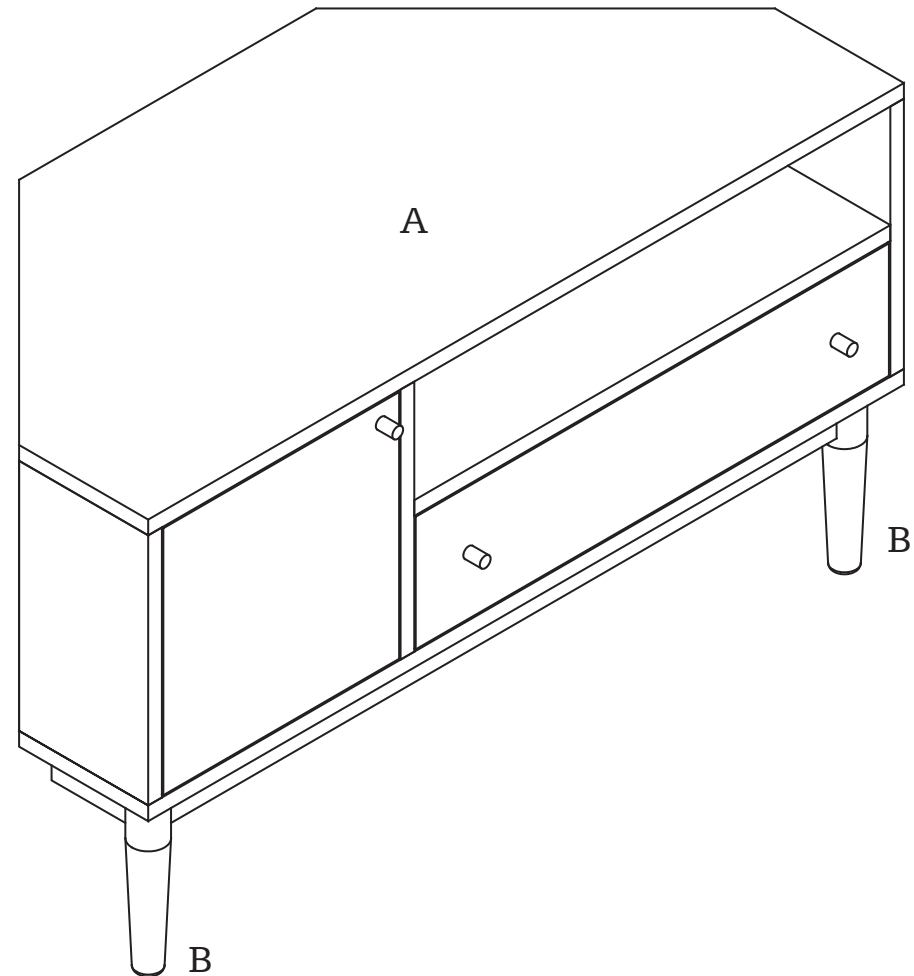

**NL** Aanwijzingen voor veilig gebruik van dit meubel worden toegelicht op de laatste pagina van deze instructies.

Bewaar deze folder goed.

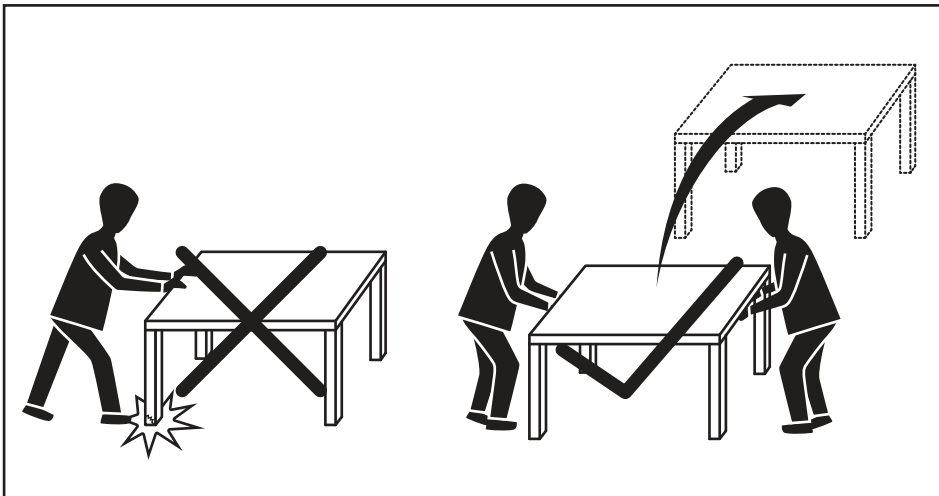
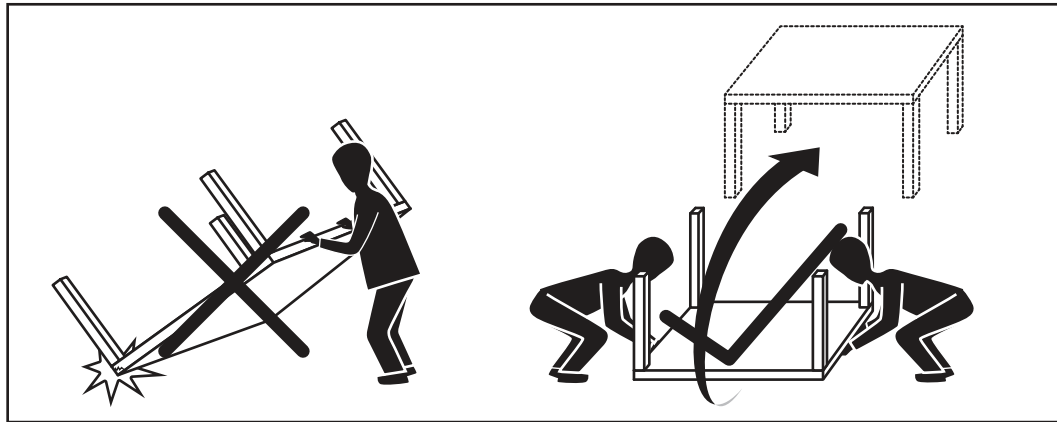
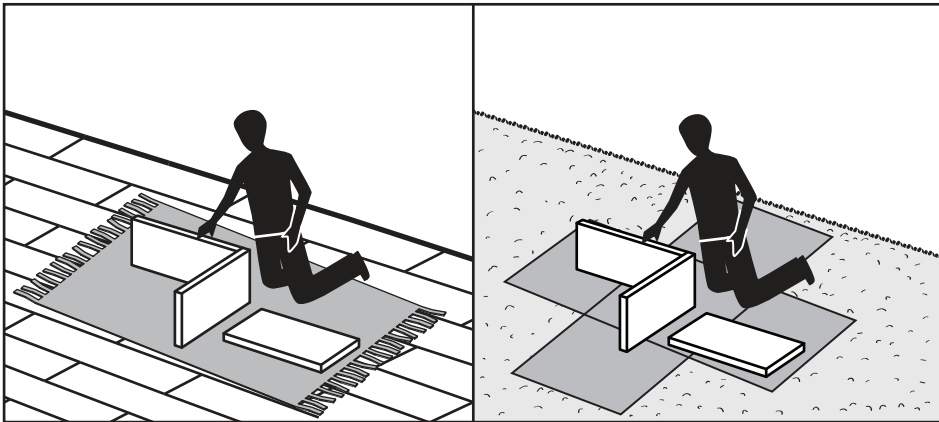
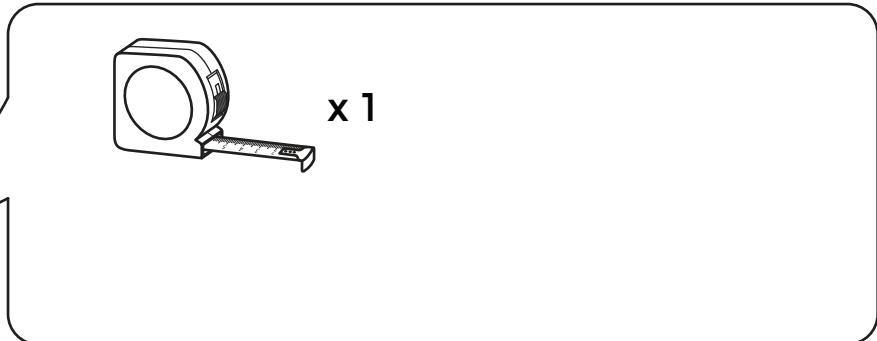
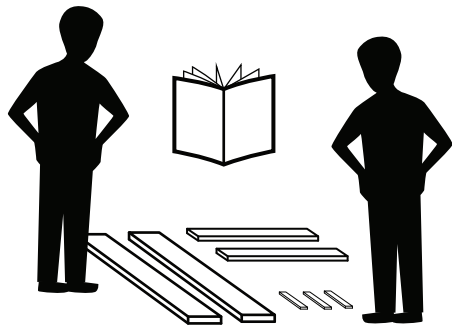
**DE** Auf der letzten Seite dieser Anleitung findest du Hinweise für eine langfristig sichere Anwendung dieses Produktes. Bitte bewahre sie gut auf.





|   |  |  |
|---|--|--|
| H1 x 1  |  |  |
|  (5#)                |  |  |
| H2 x 8  |  |  |
|  (M8 x 50mm)         |  |  |
| H3 x 8  |  |  |
|  (φ8 x φ20 x T1.5mm) |  |  |
| H4 x 8  |  |  |
|  (φ8 x φ13 x T2.0mm) |  |  |

1

