

# MADE<sup>+</sup>

NYRO

Nyro Pendant Lamp

Nyro, suspension

Nyro hanglamp

Nyro Pendelleuchte

Lámpara suspendida Nyro



**EN** Indoor use only.

**FR** À réserver exclusivement à un usage intérieur.

**NL** Alleen binnen gebruiken.

**DE** Nur für den Innengebrauch.

**ES** Solo para uso interior.

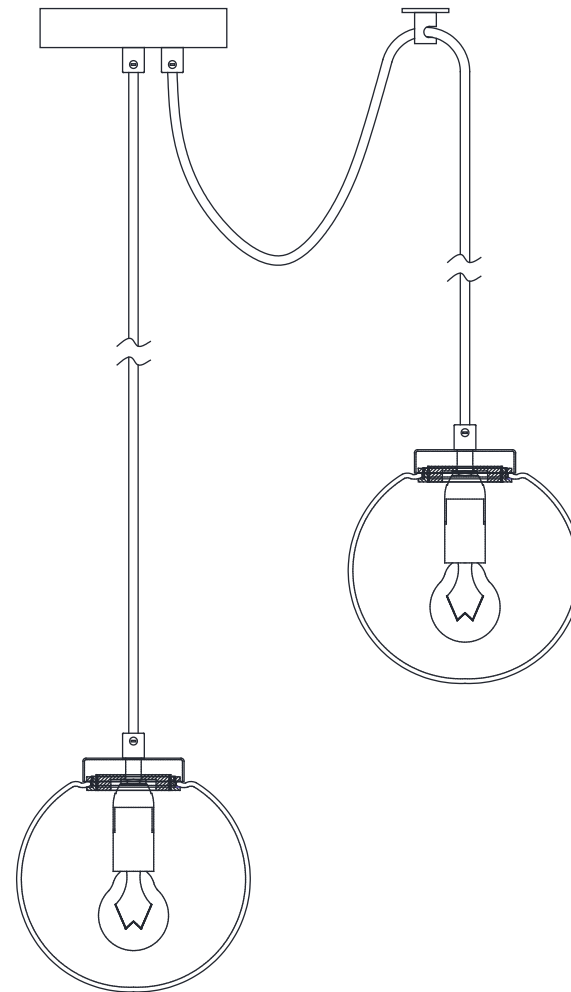



## SAFETY DISCLAIMER

---

**EN - IMPORTANT!** Always shut off power to the circuit before starting installation work. In some countries electrical installation work may only be carried out by a authorised electrical contractor. Contact your local electricity authority for advice.

**FR - ATTENTION !** Toujours couper l'alimentation au panneau principal avant de procéder à l'installation. Dans certains pays, l'installation doit être effectuée par un électricien qualifié. Pour en savoir plus, contacter les autorités locales compétentes en la matière.

**NL - BELANGRIJK!** Schakel de stroom altijd uit voordat met de installatie wordt begonnen. In sommige landen mogen elektrische installaties alleen worden uitgevoerd door een bevoegd elektricien. Neem daarom contact op met de plaatselijke overheid voor advies.

**DE - WICHTIG!** Vor der Installation den Strom abschalten. In einigen Ländern dürfen Elektroinstallationen nur von autorisierten Elektrofachleuten ausgeführt werden. Im Zweifelsfall die örtlichen Behörden ansprechen.

**ES - IMPORTANTE!** Desconecta siempre el interruptor general de la electricidad antes de iniciar cualquier trabajo de instalación. En algunos países, la instalación eléctrica sólo puede realizarla un electricista profesional. Ponte en contacto con las autoridades locales para saber cuál es tu caso.



# SAFETY DISCLAIMER

---

## **External Cable: Type Y**

**EN** - If the external cable becomes damaged, it should be replaced immediately by a certified electrician.

**FR** - Si le câble externe est endommagé, il doit être remplacé immédiatement par un électricien certifié.

**NL** - Indien de buitenste kabel beschadigd raakt, dient deze zo gauw mogelijk vervangen te worden door een professionele elektricien.

**DE** - Wenn das externe Kabel beschädigt wird, sollte es sofort von einer Elektrofachkraft ersetzt werden.

**ES** - Si el cable externo está dañado, debería ser reemplazado inmediatamente por un electricista.

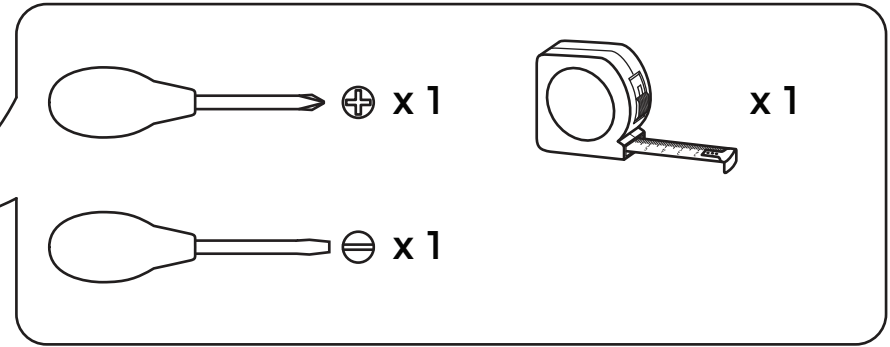
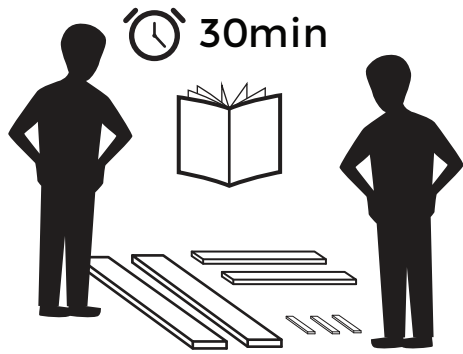

<p><b>H1 x 3</b></p>	<p><b>H4 x 1</b></p>	
<p><b>H2 x 3</b></p>	<p><b>H5 x 1</b></p>	
<p><b>H3 x 1</b></p>	<p><b>H6 x 1</b></p>	

1

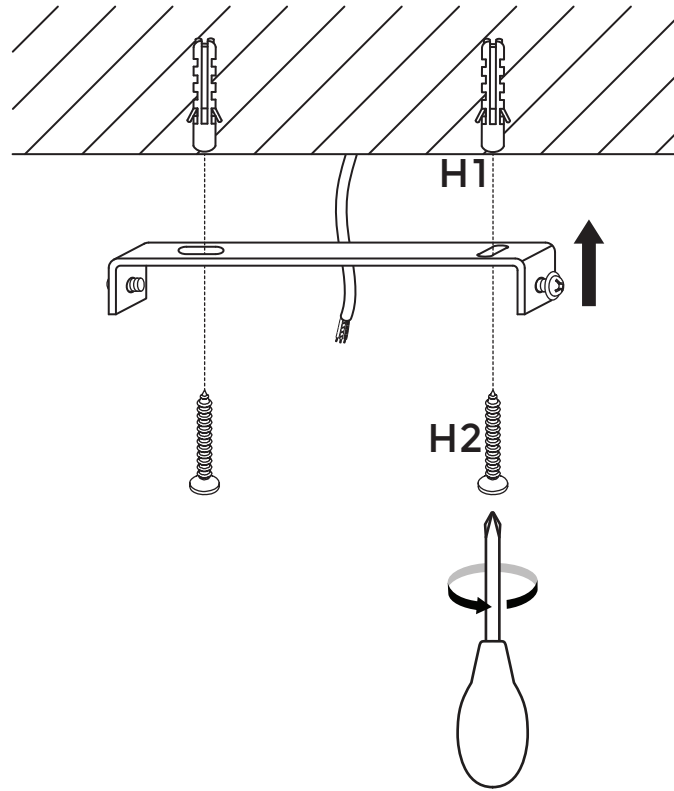

# 2

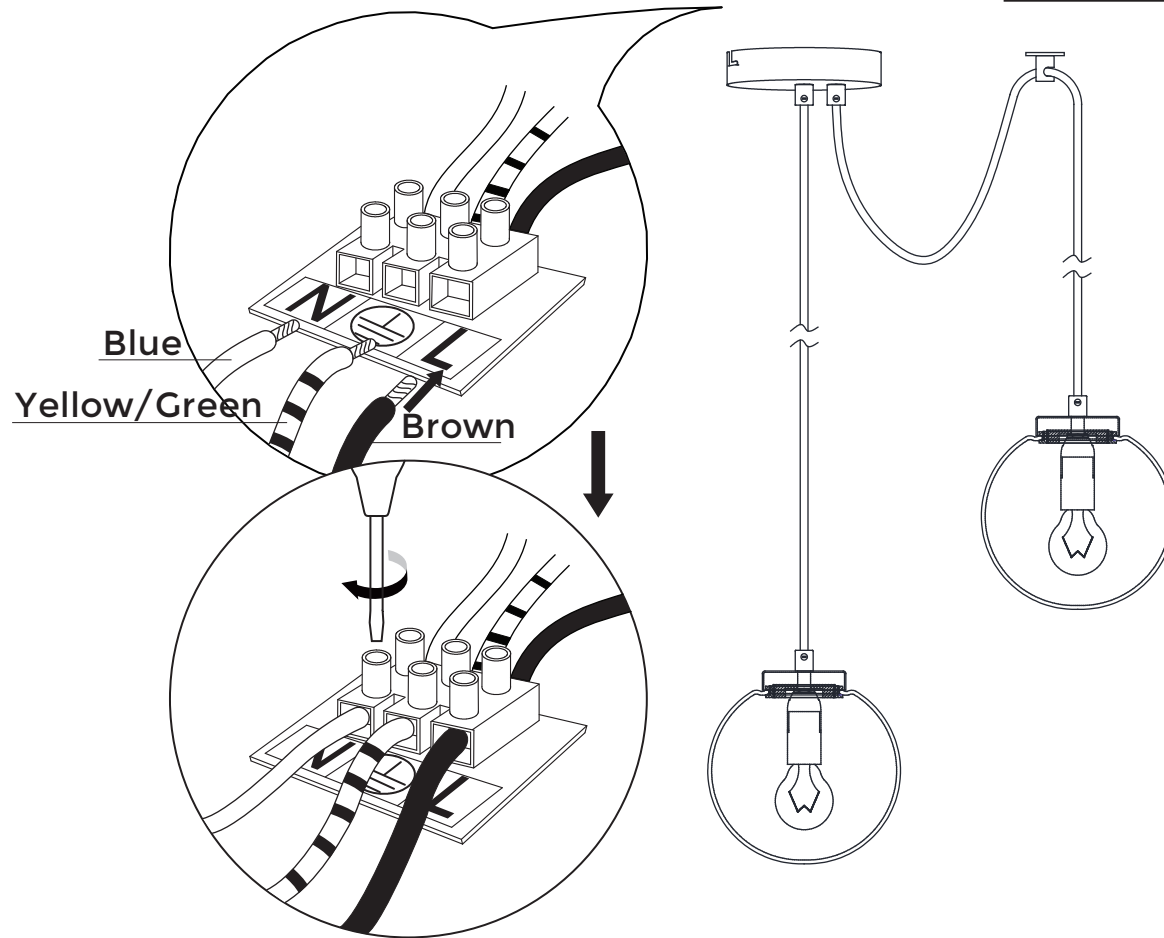

# 3

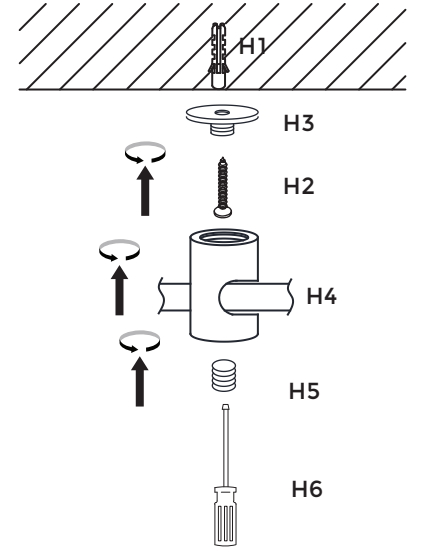
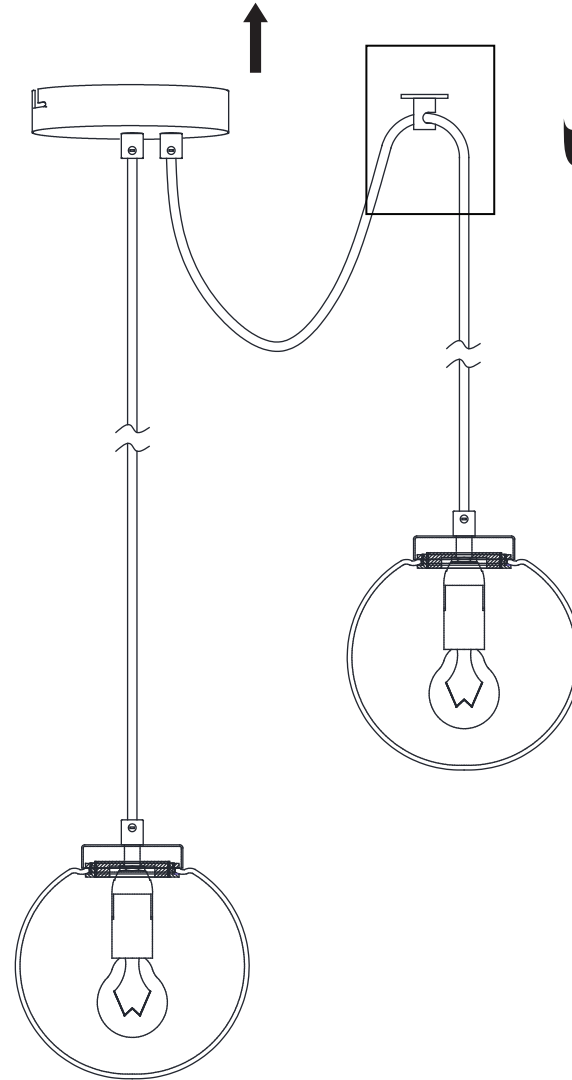
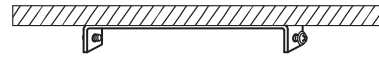
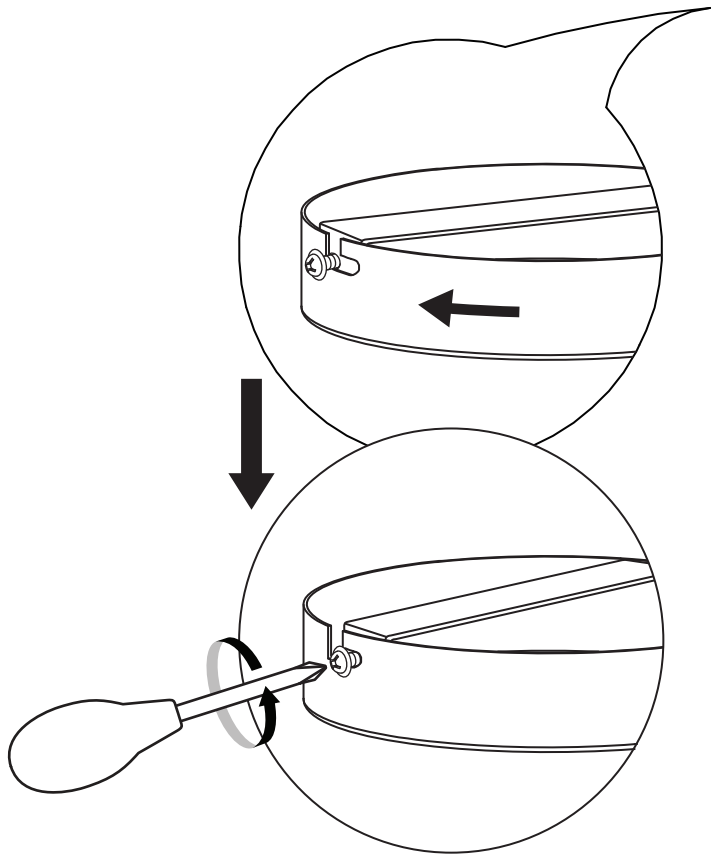

# 4

