

# MADE<sup>+</sup>

MADISON

Madison Floor Lamp

Madison, lampe de sol

Lampada da terra Madison

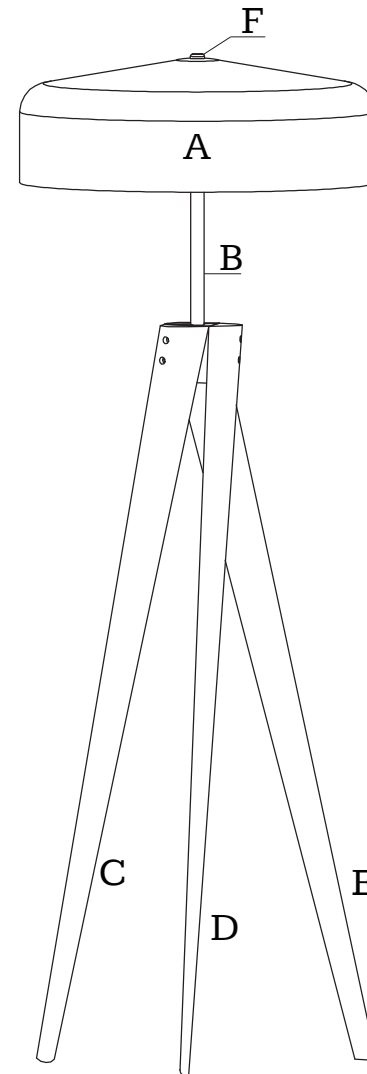

Madison staande lamp

Madison Stehlampe





# SAFETY DISCLAIMER

 E14 2 x MAX.40W  
 E14 2 x MAX.28W  
 E14 2 x MAX.11W  
220-240V~50Hz

## ENGLISH

### Safety:

1. Indoor use only.
2. The external flexible cable or cord of this luminaire cannot be replaced; if the cord is damaged, the luminaire shall be destroyed.
3. Before inserting or replacing the bulb(s), make sure that the light is unplugged and has cooled down.
4. Never fit a bulb of greater wattage than recommended.
5. This product is not suitable for children under 14 years of age.
6.  This means the minimum distance from lighted object is 0.3M.

### Note:

1. Bulb is not included.

## FRANÇAIS

### Précautions d'utilisation:

1. À réserver exclusivement à un usage

intérieur.

2. Le cordon d'alimentation et le câble extérieur de ce luminaire ne peuvent être remplacés. Si l'un de ces éléments est endommagé, le luminaire doit être détruit.
3. Débranchez et laissez refroidir le luminaire avant de placer ou de changer la ou les ampoules.
4. Ne jamais essayer de visser une ampoule d'une puissance plus importante que celle recommandée.
5. Ce produit n'est pas adapté aux enfants de moins de 14 ans.
6.  Cela signifie que la distance minimale de l'objet éclairé doit être de 0.3M.

### Attention:

1. L'ampoule n'est pas comprise.

## ITALIANO

### Precauzioni per l'uso:

1. Adatta per un uso esclusivamente interno.
2. Il cavo flessibile esterno e il filo elettrico di questo prodotto non si possono sostituire. Se si danneggiano,

il prodotto deve essere distrutto.

3. Staccare la spina e lasciare raffreddare prima di inserire o cambiare la lampadina.
4. Non montare mai una lampadina di potenza maggiore di quanto raccomandato.
5. Questo prodotto non è adatto per bambini sotto i 14 anni di età.
6.  Questo significa che la distanza minima dall'oggetto illuminato deve essere 0.3M.

### Nota:

1. Lampadina non inclusa.

## NEDERLANDS

### Veiligheid:

1. Alleen binnen gebruiken.
2. De buitenste flexibele kabel of het koord van de lamp kunnen niet vervangen worden. Indien het koord beschadigd raakt, is de hele lamp aan vervanging toe.
3. Om een nieuw peertje of lampje te plaatsen of een oud exemplaar te vervangen, vergeet niet ervoor te zorgen dat de lamp uitgeschakeld is en

afgekoeld is.

4. Gebruik nooit een lamp met hogere Wattage dan aangeraden.
5. Dit product is niet geschikt voor kinderen jonger dan 14 jaar.
6.  Dit betekent dat de minimale afstand tot het lichtobject 0,3m is.

**Belangrijk:**

1. Lampje niet inbegrepen.

**DEUTSCH**

**Sicherheit:**

1. Nur für den Innengebrauch.
2. Das Anschlusskabel dieser Leuchte kann nicht ersetzt werden; wenn das Kabel beschädigt ist, muss die ganze Lampe entsorgt werden.
3. Vor dem Einlegen oder Auswechseln der Glühlampe(n), stellen Sie sicher, dass das die Lampe nicht an den Strom angeschlossen und abgekühlt ist.
4. Setzen Sie nie eine Glühbirne von mehr Leistung als empfohlen ein.
5. Das Produkt ist nicht für Kinder unter 14 Jahren geeignet.
6.  Das heißt, der Mindestabstand zum beleuchteten Objekt ist 30cm.

**Hinweis:**

1. Lampe ist nicht enthalten.

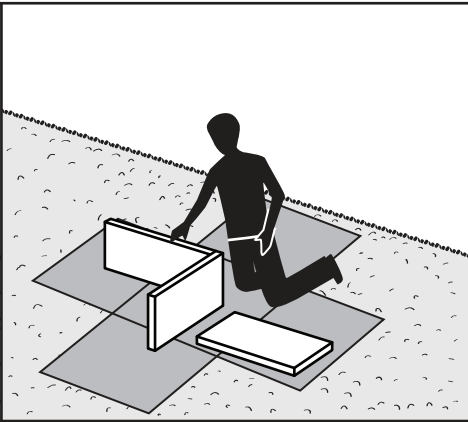
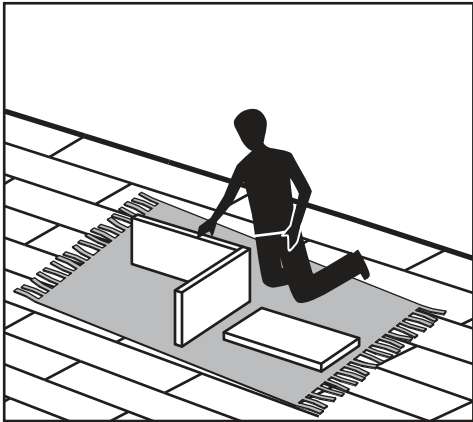
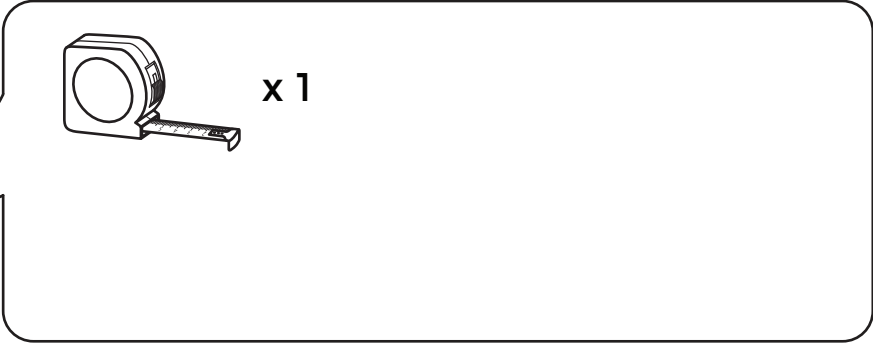
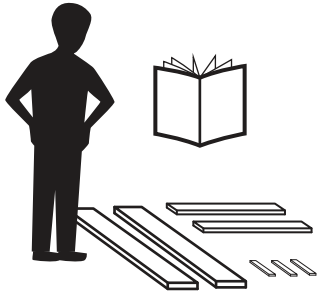

H1 x 1



(5#)

H2 x 6



(M6 x 30)

# 1

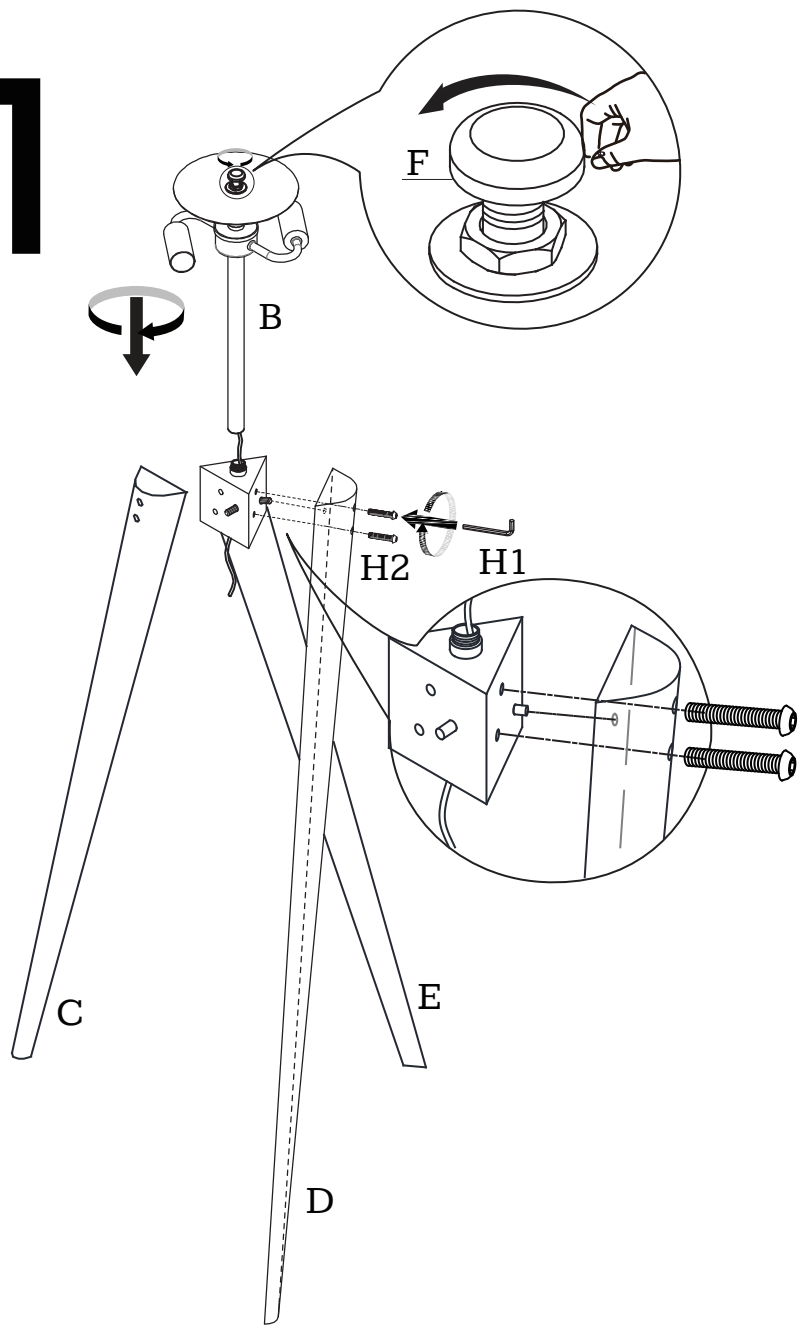

# 2

