

# MADE<sup>+</sup>

BOW

Large Bow Lamp

Large Bow, lampadaire

Large Bow Lampada da Terra ad Arco

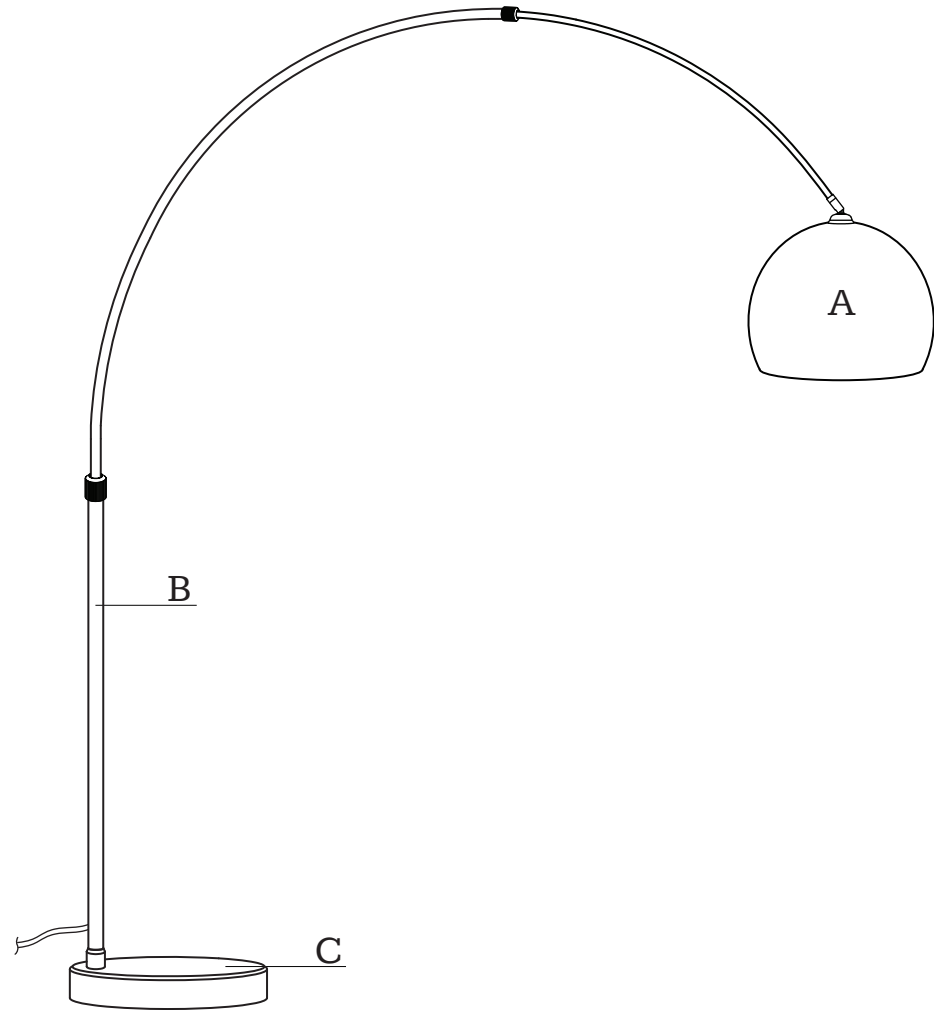

Large Bow Lamp

Large Bow lampe





# SAFETY DISCLAIMER

 E27 1 x MAX.40W  
 E27 1 x MAX.11W  
220-240V~50Hz

## ENGLISH

### Safety:

1. Indoor use only.
2. If the external cable becomes damaged, it should be replaced immediately by a certified electrician.
3. Before inserting or replacing the bulb(s), make sure that the light is unplugged and has cooled down.
4. Never fit a bulb of greater wattage than recommended.
5. This product is not suitable for children under 14 years of age.
6.  This means the minimum distance from lighted object is 0.3M.

### Note:

1. Bulb is not included.

## FRANÇAIS

### Précautions d'utilisation:

1. À réserver exclusivement à un usage intérieur.
2. Si le câble externe est endommagé, il doit être remplacé immédiatement par

- un électricien certifié.
3. Débranchez et laissez refroidir le luminaire avant de placer ou de changer la ou les ampoules.
  4. Ne jamais essayer de visser une ampoule d'une puissance plus importante que celle recommandée.
  5. Ce produit n'est pas adapté aux enfants de moins de 14 ans.
  6.  Cela signifie que la distance minimale de l'objet éclairé doit être de 0.3M.

### Attention:

1. L'ampoule n'est pas comprise.

## ITALIANO

### Precauzioni per l'uso:

1. Adatta per un uso esclusivamente interno.
2. Se il cavo esterno viene danneggiato, deve essere immediatamente sostituito da un elettricista qualificato.
3. Staccare la spina e lasciare raffreddare prima di inserire o cambiare la lampadina.
4. Non montare mai una lampadina di potenza maggiore di quanto raccomandato.
5. Questo prodotto non è adatto per

bambini sotto i 14 anni di età.

6.  Questo significa che la distanza minima dall'oggetto illuminato deve essere 0.3M.

### Nota:

1. Lampadina non inclusa.

## NEDERLANDS

### Veiligheid:

1. Alleen binnen gebruiken.
2. Indien de buitenste kabel beschadigd raakt, dient deze zo gauw mogelijk vervangen te worden door een professionele elektricien.
3. Om een nieuw peertje of lampje te plaatsen of een oud exemplaar te vervangen, vergeet niet ervoor te zorgen dat de lamp uitgeschakeld is en afgekoeld is.
4. Gebruik nooit een lamp met hogere Wattage dan aangeraden.
5. Dit product is niet geschikt voor kinderen jonger dan 14 jaar.
6.  Dit betekent dat de minimale afstand tot het lichtobject 0,3m is.

### Belangrijk:

1. Lampje niet inbegrepen.

## DEUTSCH





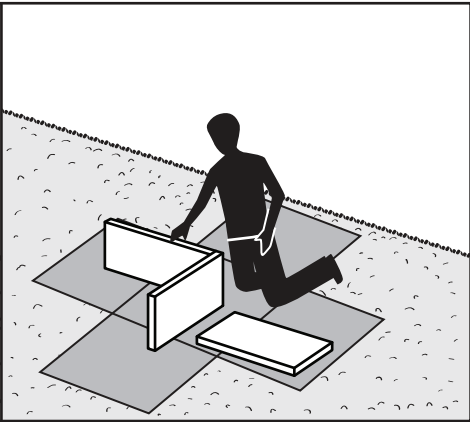
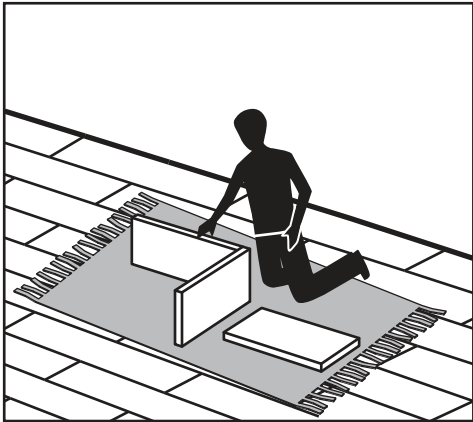
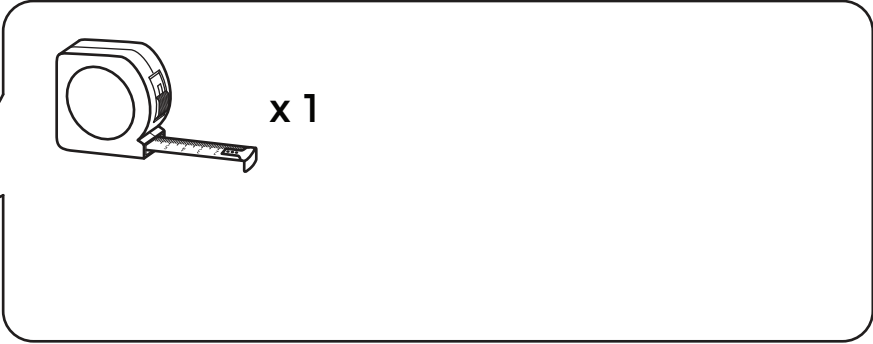
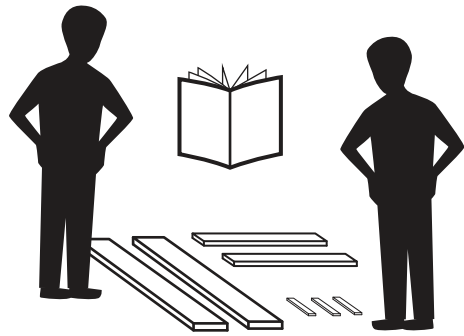

**Sicherheit:**

1. Nur für den Innengebrauch.
2. Wenn das externe Kabel beschädigt wird, sollte es sofort von einer Elektrofachkraft ersetzt werden.
3. Vor dem Einlegen oder Auswechseln der Glühlampe(n), stellen Sie sicher, dass die Lampe nicht an den Strom angeschlossen und abgekühlt ist.
4. Setzen Sie nie eine Glühbirne von mehr Leistung als empfohlen ein.
5. Das Produkt ist nicht für Kinder unter 14 Jahren geeignet.
6.  Das heißt, der Mindestabstand zum beleuchteten Objekt ist 30cm.

**Hinweis:**

1. Lampe ist nicht enthalten.



<p>H1 x 1   (14# - 17#)</p> <p>H2 x 1   (1/8 - 27T x H79)</p> <p>H3 x 1   (φ40 x T1.5)</p> <p>H4 x 1  </p>	<p>H5 x 1  </p> <p>H6 x 1   (φ16 x T3)</p>	
--	--	--

# 1

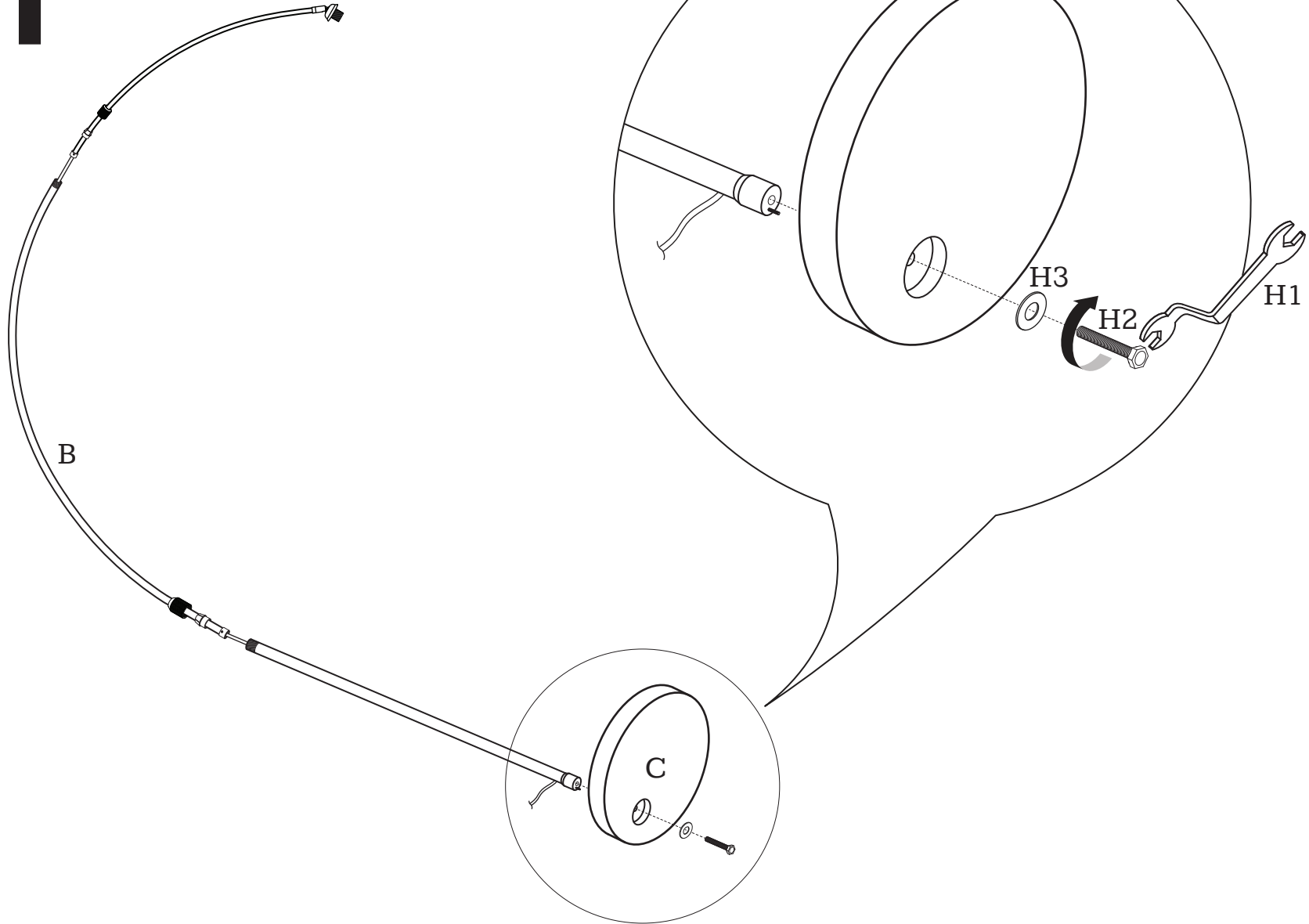

# 2

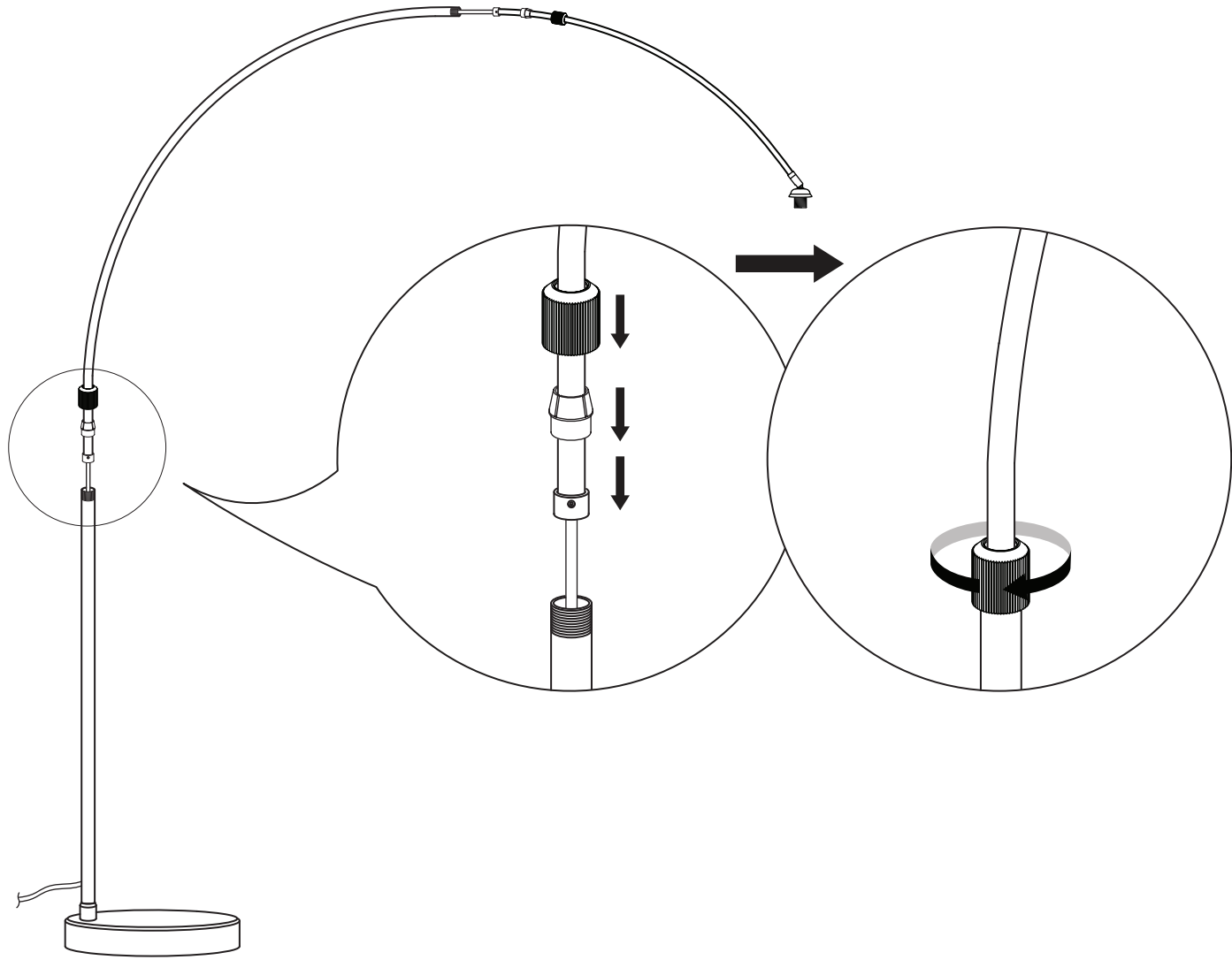

# 3

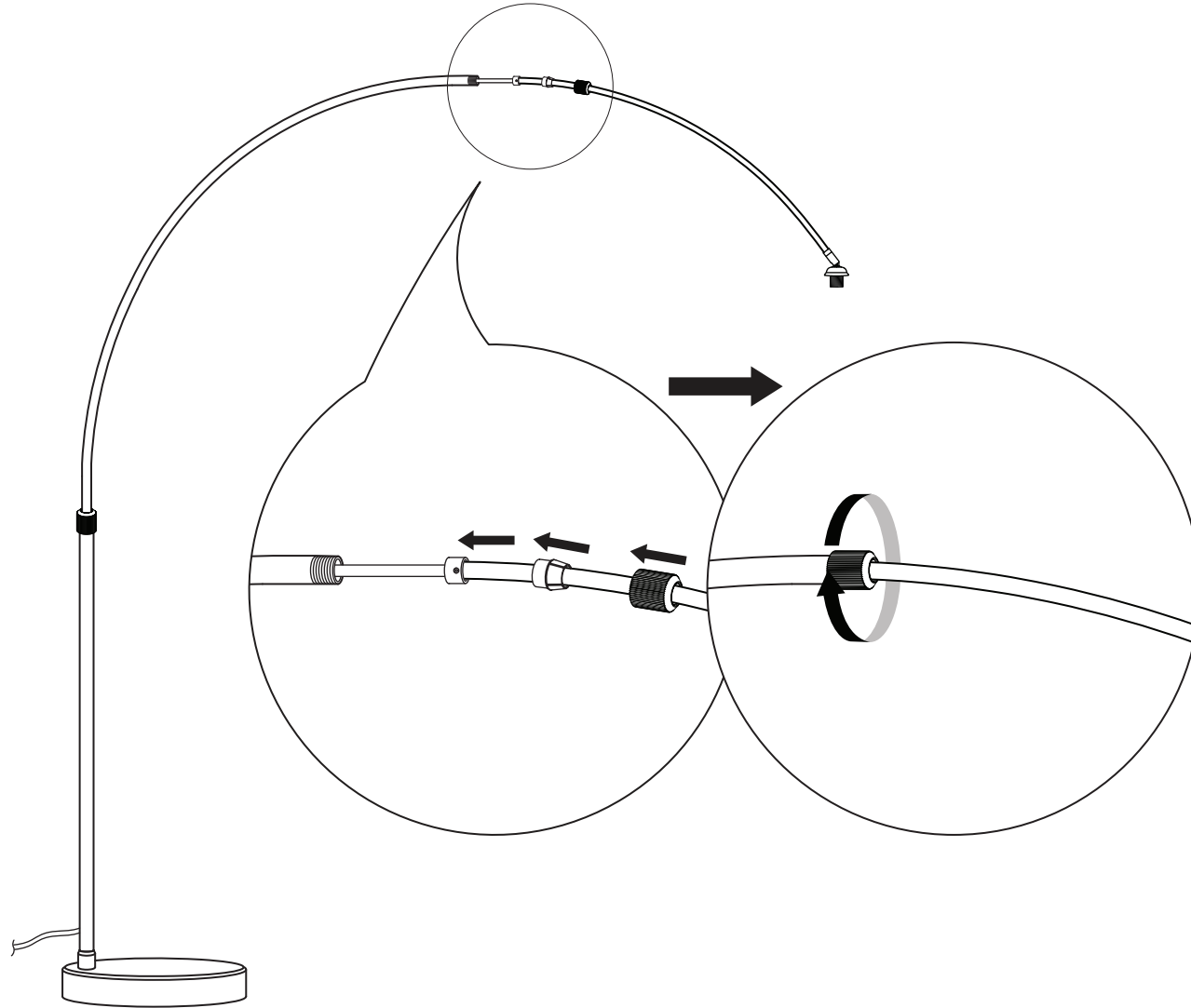

4

