

MADE⁺

WADE

Wade Freestanding Wood Mirror

Wade, miroir en bois sur pieds

Wade spiegel met houten lijst

Wade freistehender Spiegel

Wade freistehender Spiegel



GB Recommendations for the continual safe use of this product are stated on the final page of these instructions. Please retain for future reference.

FR Les conseils d'utilisation de ce produit sont indiqués sur la dernière page de ces instructions. Veuillez les conserver pour vous y référer si besoin.







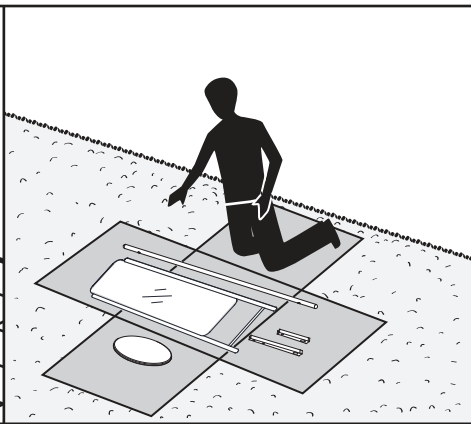
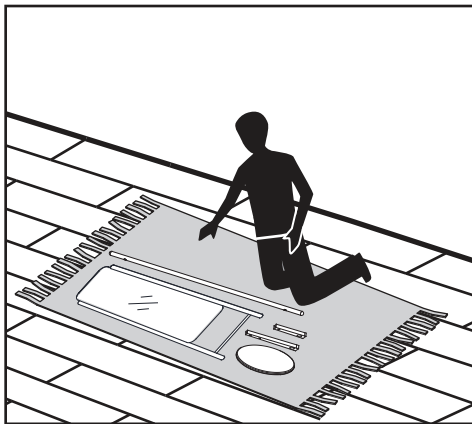
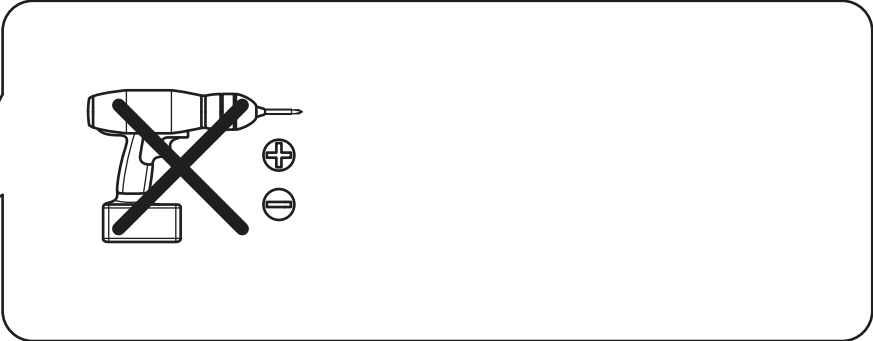
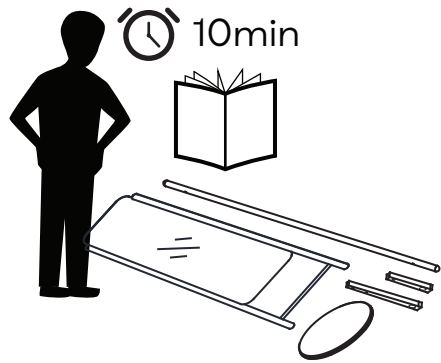

NL Aanwijzingen voor veilig gebruik van dit meubel worden toegelicht op de laatste pagina van deze instructies. Bewaar deze folder goed.

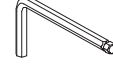
DE Auf der letzten Seite dieser Anleitung findest du Hinweise für eine langfristig sichere Anwendung dieses Produktes. Bitte bewahre sie gut auf.

ES Las recomendaciones para el uso continuado de este producto figuran en la última página de estas instrucciones. Por favor, consérvalas para futuras consultas.

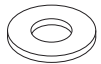

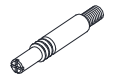

<p>H1 x 1  (4#)</p> <p>H2 x 1  (6#)</p> <p>H3 x 3  (M6 x 35)</p>	<p>H4 x 2  (M6 x 50)</p> <p>H5 x 2  (φ6.5 x φ11 x T2)</p> <p>H6 x 2  (φ6.5 x φ13 x T1.5)</p>	<p>H7 x 2  (M6 x 13)</p> <p>H8 x 2 </p> <p>H9 x 2 </p>
------------------------------------------------------------------------------------------------------------------------------------------------------------------------------------------------------------------------------------------------------------------------------------------------------------------------------------------	----------------------------------------------------------------------------------------------------------------------------------------------------------------------------------------------------------------------------------------------------------------------------------------------------------------------------------------------------------------------	--------------------------------------------------------------------------------------------------------------------------------------------------------------------------------------------------------------------------------------------------------------------------------------------------------------------------------

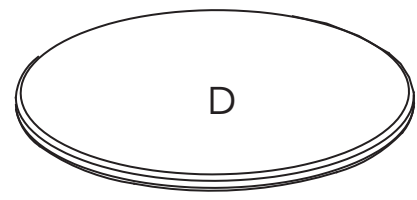
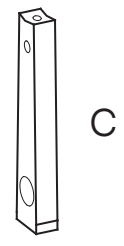
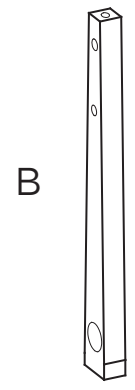
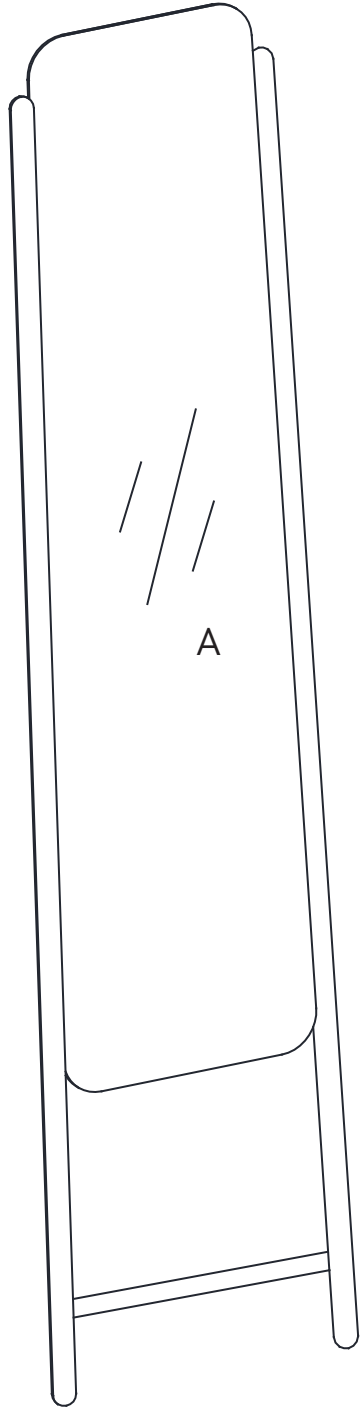

1

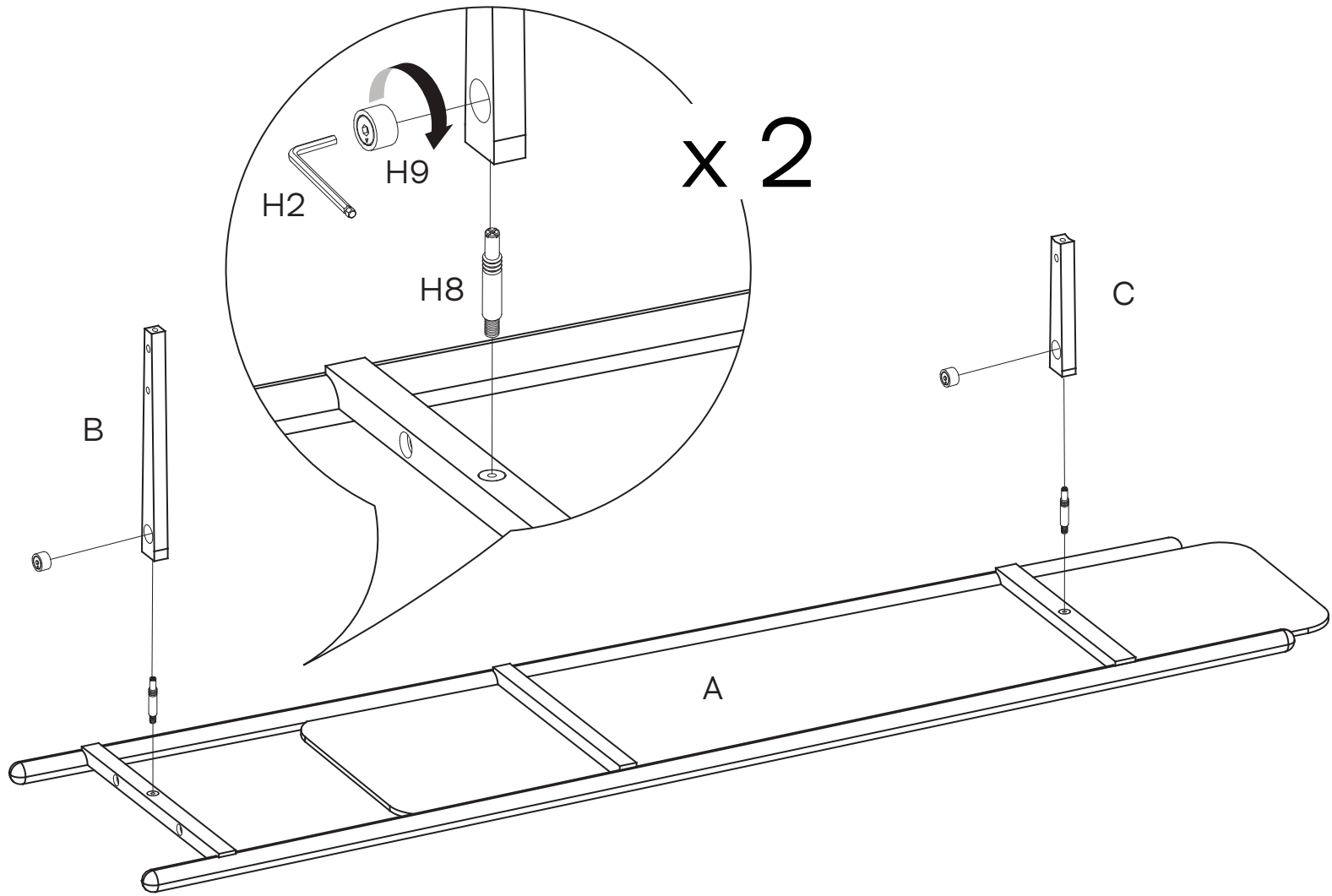

2

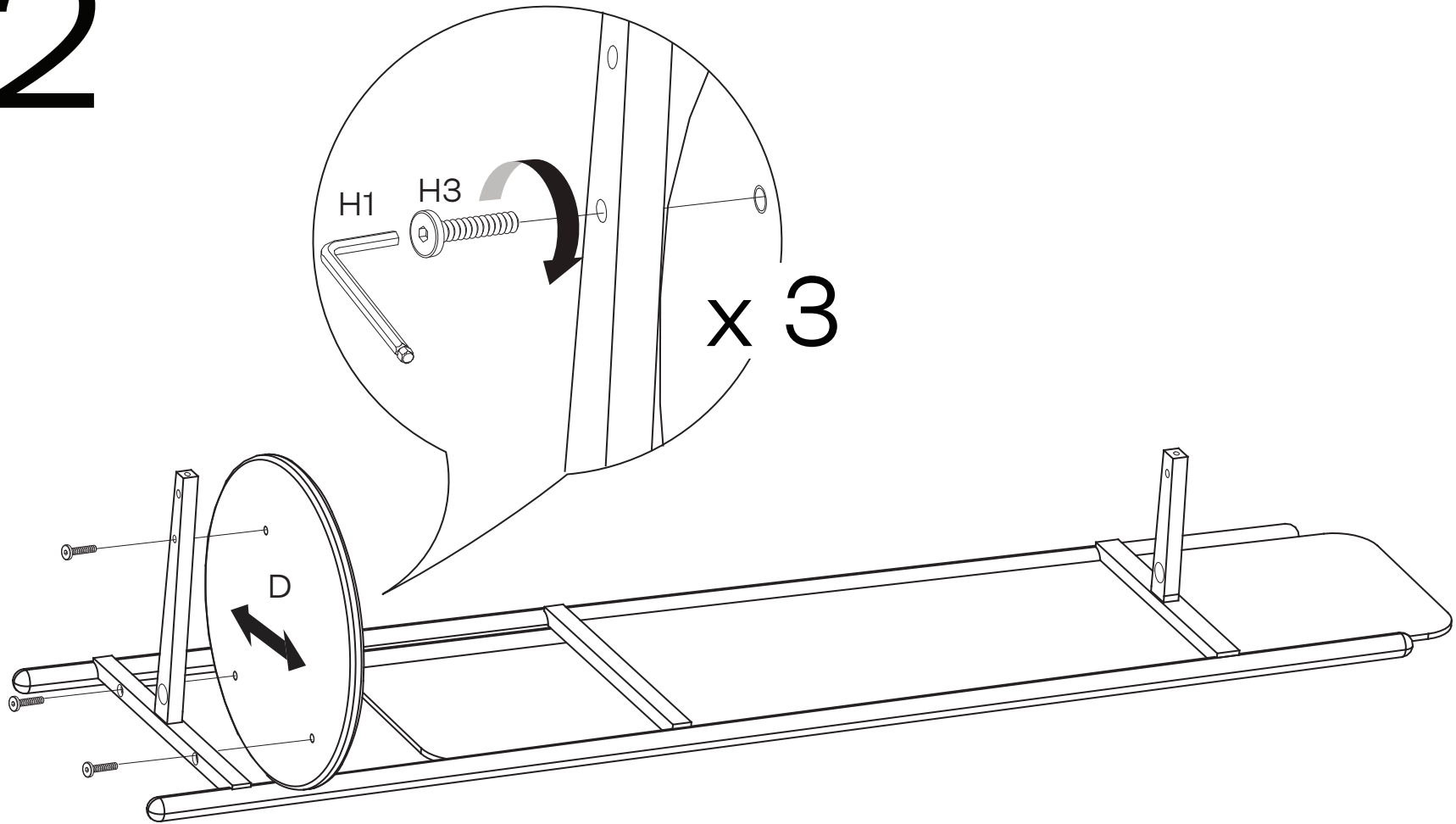

3



118.5mm

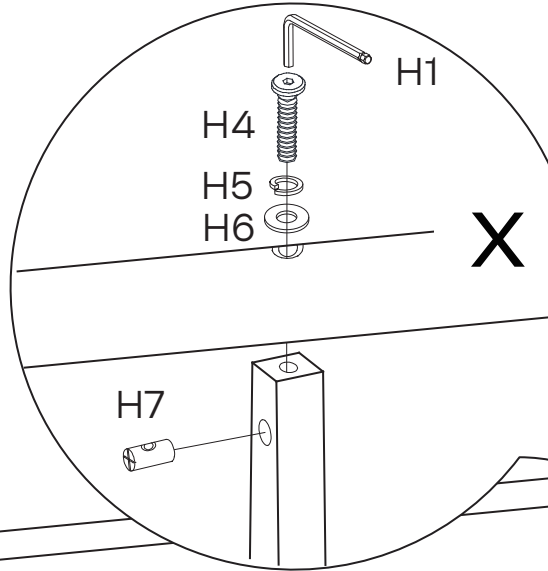

H7

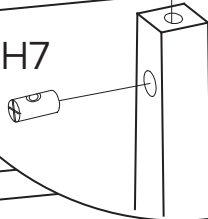

x 2



177mm

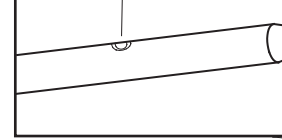

E

