

MADE⁺

LOMOND

Lomond Bar Table

Table de bar Lomond

Lomond Bar tafel

Lomond-Stehtisch

Mesa de bar Lomond



GB Recommendations for the continual safe use of this product are stated on the final page of these instructions. Please retain for future reference.

FR Les conseils d'utilisation de ce produit sont indiqués sur la dernière page de ces instructions. Veuillez les conserver pour vous y référer si besoin.

NL Aanwijzingen voor veilig gebruik van dit meubel worden toegelicht op de laatste pagina van deze instructies. Bewaar deze folder goed.

DE Auf der letzten Seite dieser Anleitung findest du Hinweise für eine langfristige sichere Anwendung dieses Produktes. Bitte bewahre sie gut auf.

ES Recomendaciones para el uso continuo y seguro de este producto se indican en la página final de estas instrucciones. por favor consévela para referencia futura.

Lomond Bar Table MK 2 20201124
Made in India

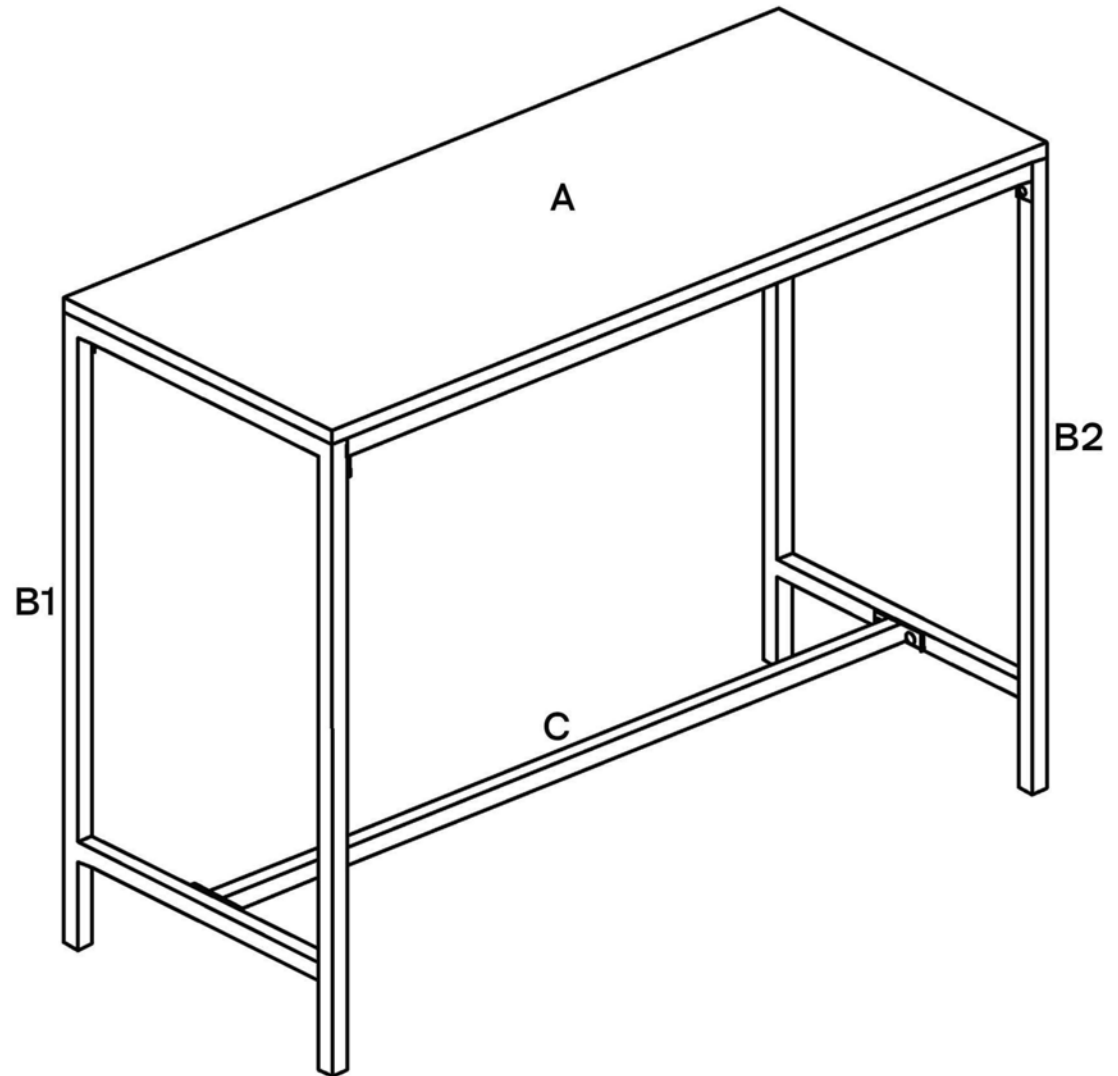

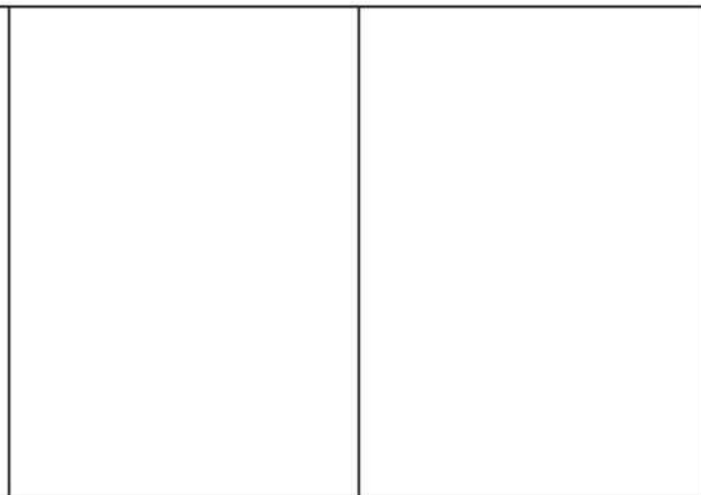
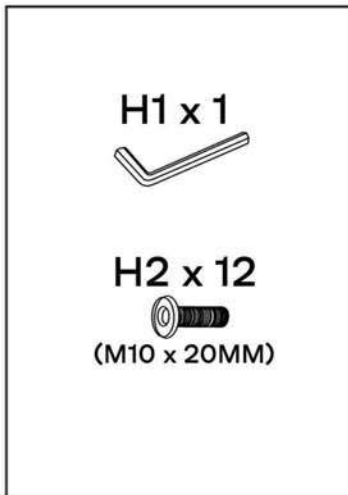
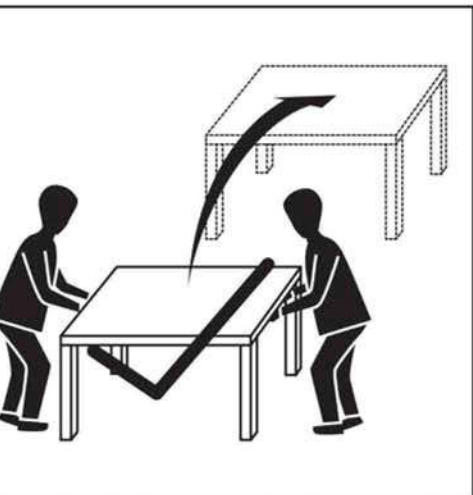
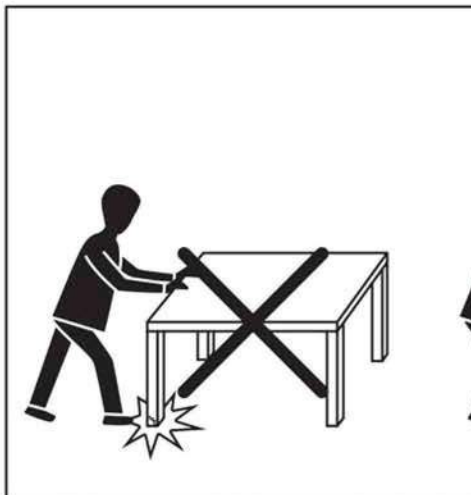
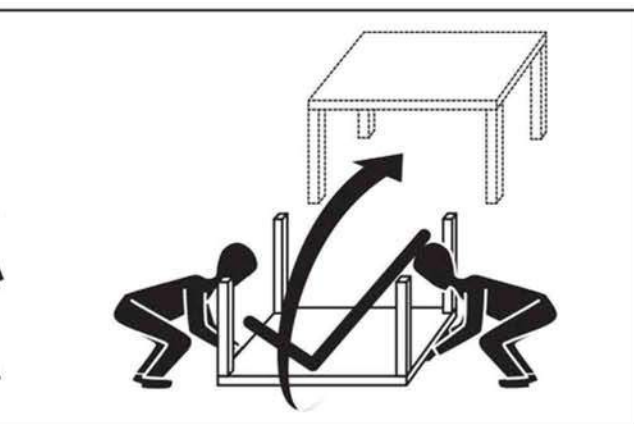
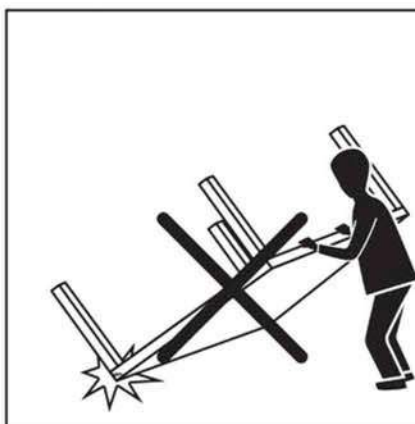
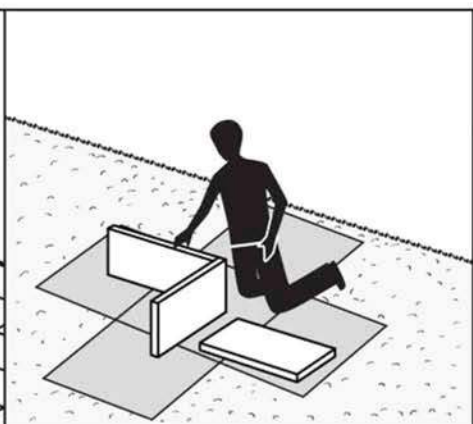
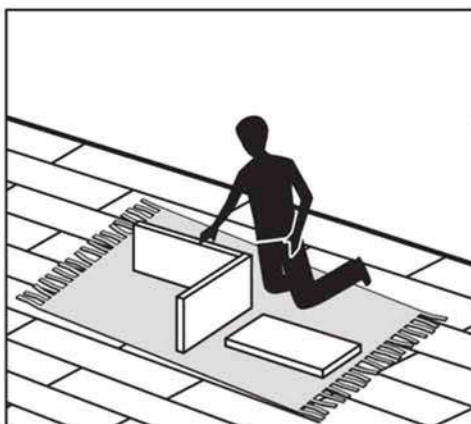
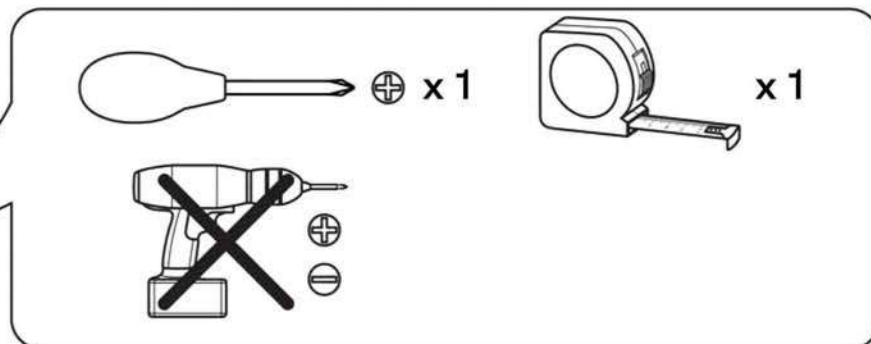
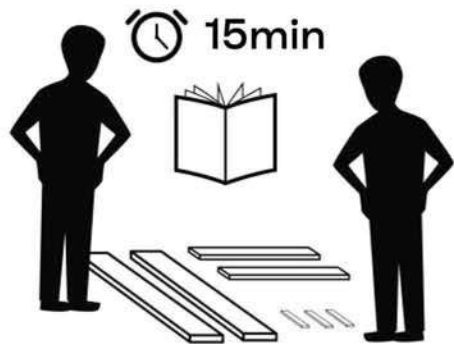

1

