

MADE⁺

BRIZ

Briz Wall Lamp

Briz, applique murale

Briz wandlamp

Briz Wandleuchte

Lámpara de pared Briz



EN Indoor use only.

FR À réserver exclusivement à un usage intérieur.

NL Alleen binnen gebruiken.

DE Nur für den Innengebrauch.

ES Solo para uso interior.

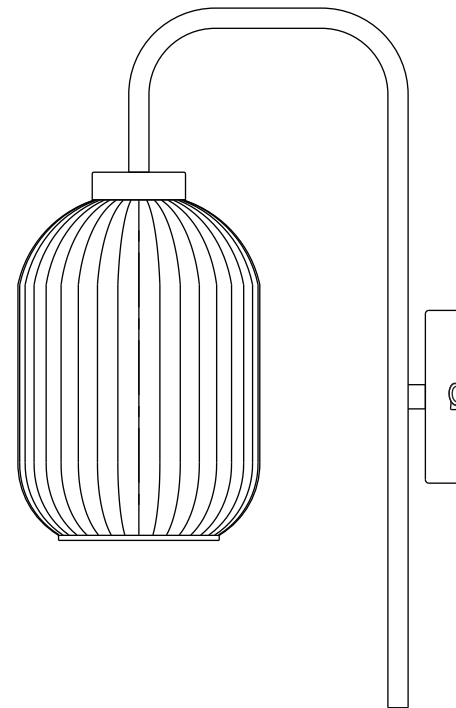



SAFETY DISCLAIMER

EN - IMPORTANT! Always shut off power to the circuit before starting installation work. In some countries electrical installation work may only be carried out by a authorised electrical contractor. Contact your local electricity authority for advice.

FR - ATTENTION ! Toujours couper l'alimentation au panneau principal avant de procéder à l'installation. Dans certains pays, l'installation doit être effectuée par un électricien qualifié. Pour en savoir plus, contacter les autorités locales compétentes en la matière.

NL - BELANGRIJK! Schakel de stroom altijd uit voordat met de installatie wordt begonnen. In sommige landen mogen elektrische installaties alleen worden uitgevoerd door een bevoegd elektricien. Neem daarom contact op met de plaatselijke overheid voor advies.

DE - WICHTIG! Vor der Installation den Strom abschalten. In einigen Ländern dürfen Elektroinstallationen nur von autorisierten Elektrofachleuten ausgeführt werden. Im Zweifelsfall die örtlichen Behörden ansprechen.

ES - IMPORTANTE! Desconecta siempre el interruptor general de la electricidad antes de iniciar cualquier trabajo de instalación. En algunos países, la instalación eléctrica sólo puede realizarla un electricista profesional. Ponte en contacto con las autoridades locales para saber cuál es tu caso.



SAFETY DISCLAIMER



Halogen lamps

EN - WHEN CHANGING LAMPS - Make sure the new lamp is marked with the symbol above. Halogen lamps get very hot. Allow the lamp to cool before changing lamps.

FR - EN CHANGEANT LES AMPOULES: Vérifiez que les ampoules neuves possèdent bien le symbole cidessus. Les ampoules halogènes peuvent devenir très chaudes, laissez leur le temps de refroidir avant de les changer.

NL - HET VERWISSELEN VAN LAMPJESZorg ervoor dat het nieuwe peertje of lampje gemarkeerd is met het bovenstaande symbool. Hallogeen lampen worden erg warm. Laat de lamp eerst afkoelen voor je begint met het verwisselen.

DE - Stellen Sie beim Lampenwechsel sicher, dass die neue Lampe mit dem Symbol oben markiert ist. Halogenlampen werden sehr heiß. Lassen Sie die Lampe vor dem Lampenwechsel abkühlen.

ES - CAMBIO DE BOMBILLAS - Asegúrate de que la nueva bombilla esté marcada con el símbolo de arriba. Las bombillas halógenas se calientan mucho. Deja que la lámpara se enfríe antes de cambiar las bombillas.

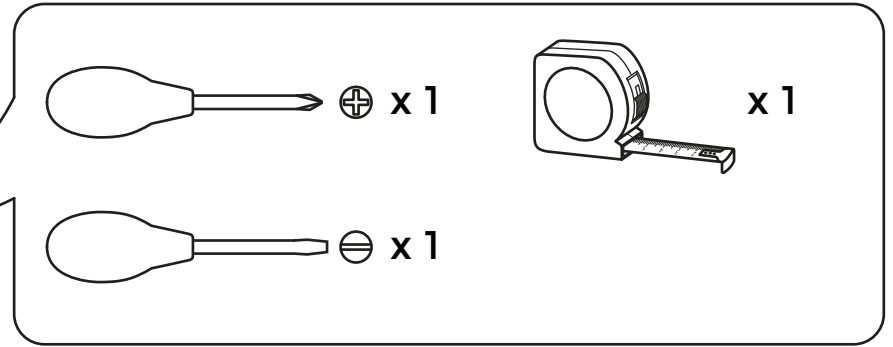
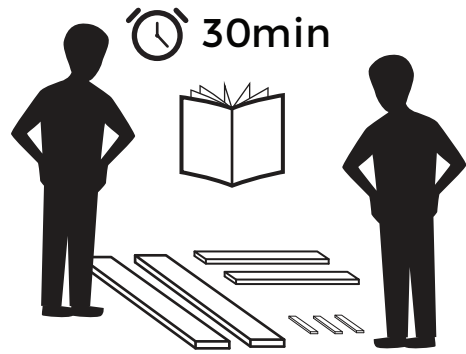

H1 x 2

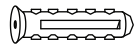

H2 x 2

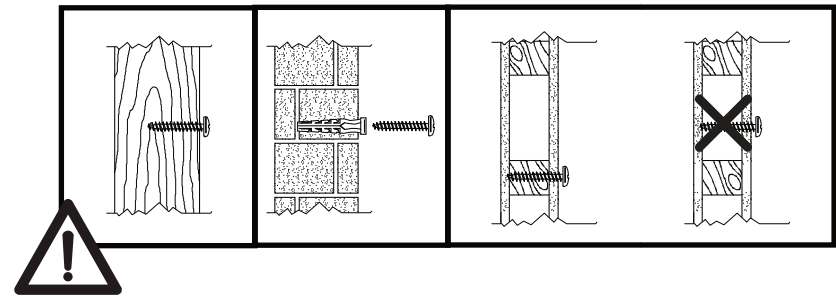

1

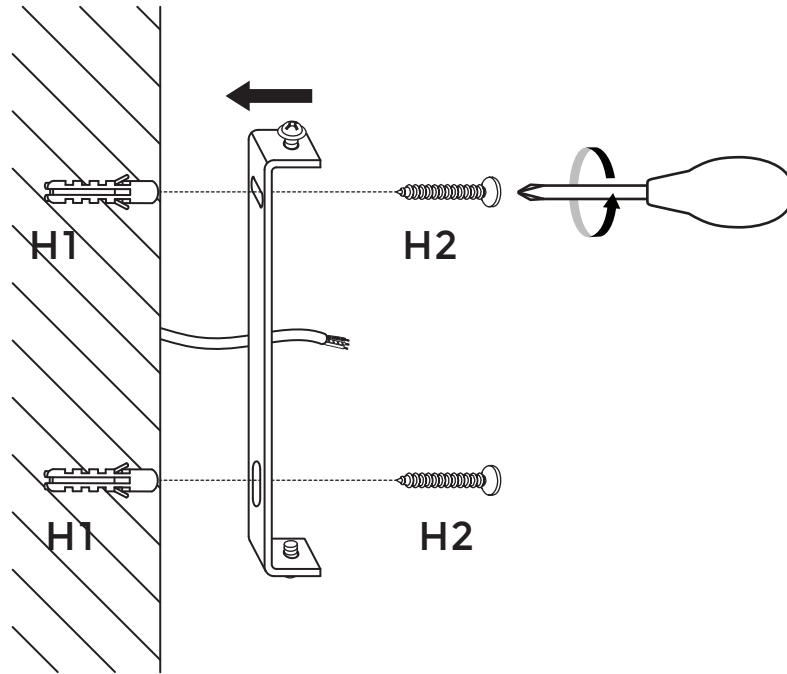

2

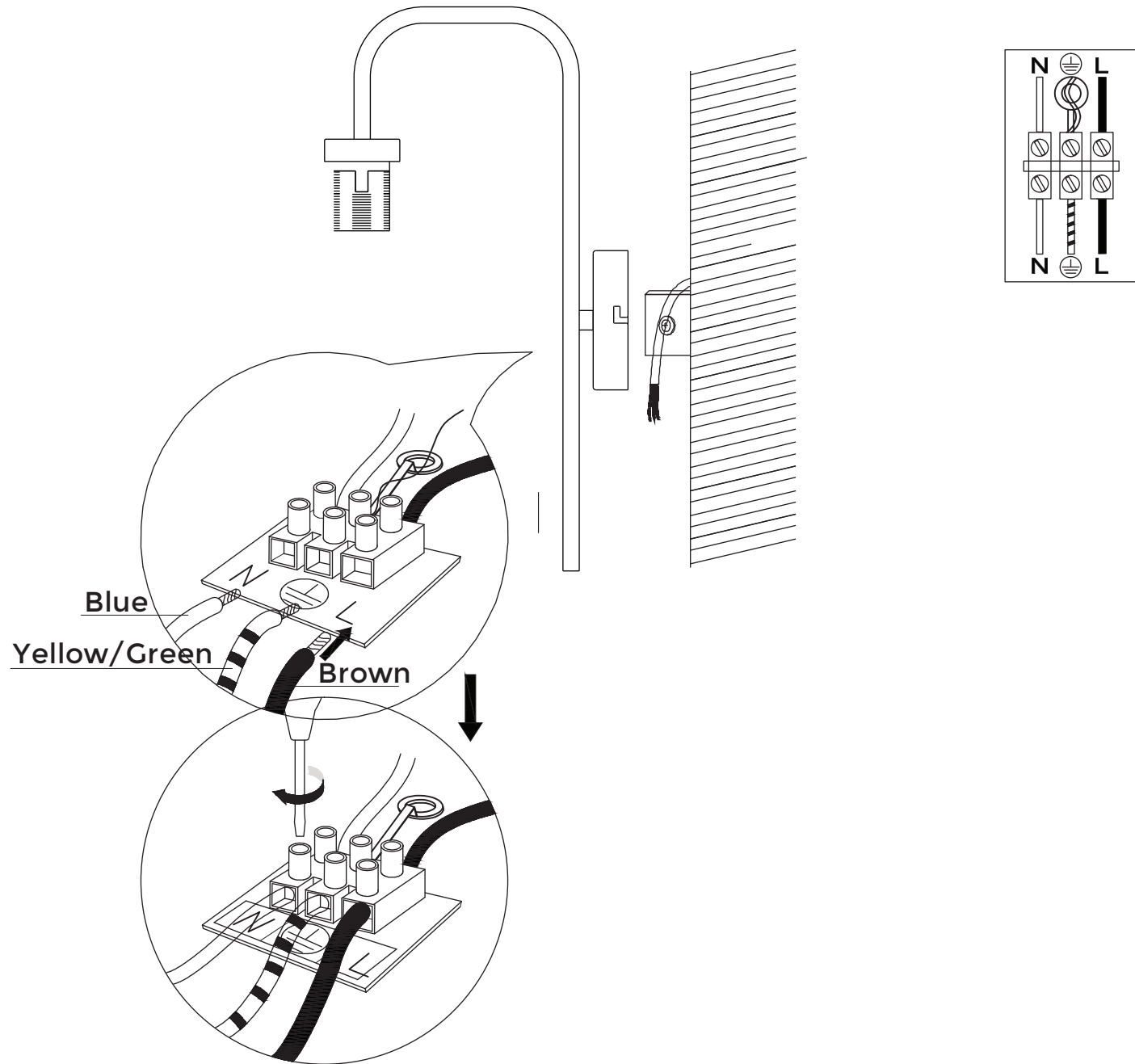

3

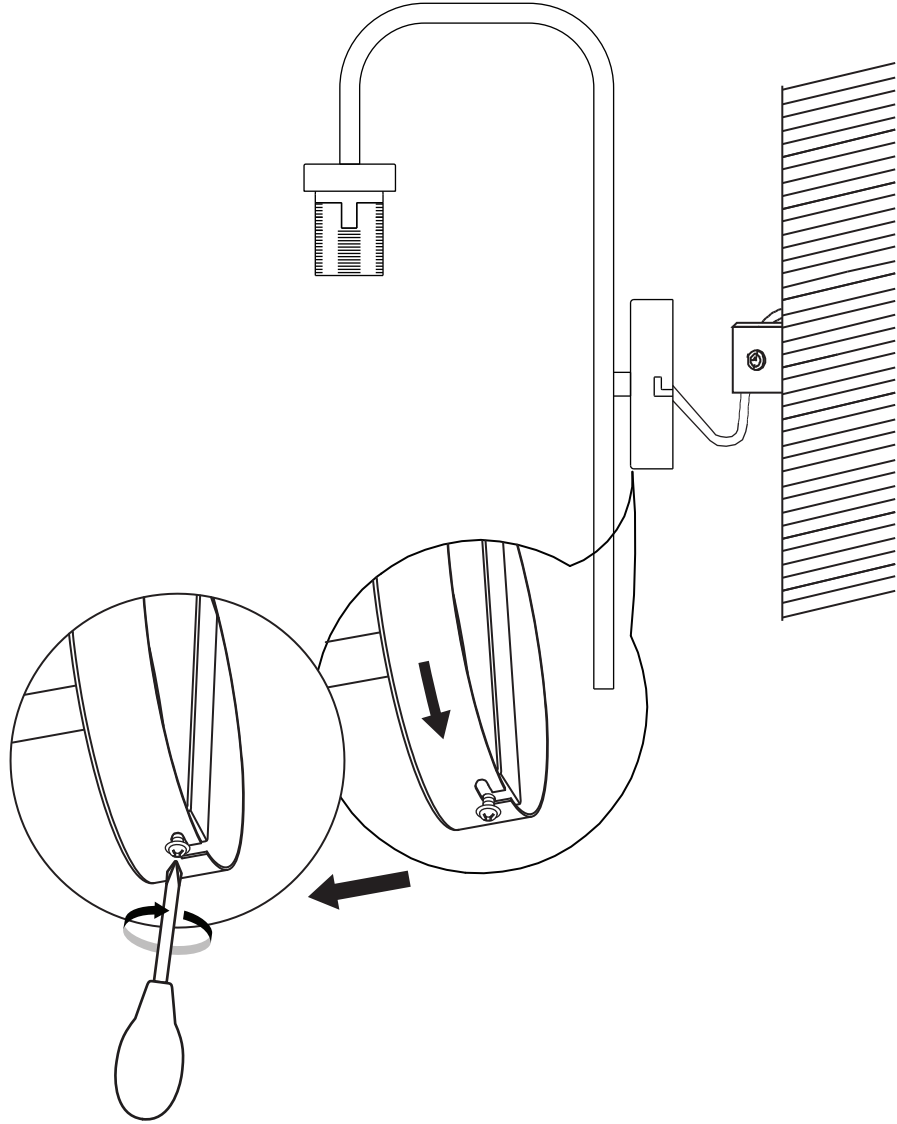

4

